

## SiC SBD P3D06016K3 650V SiC Schottky Diode

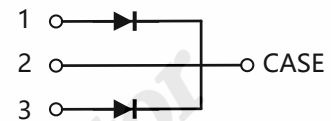

### Features

- Qualified to AEC-Q101
- Ultra-Fast Switching
- Zero Reverse Recovery Current
- High-Frequency Operation
- Positive Temperature Coefficient on  $V_F$
- High Surge Current
- 100% UIS tested



TO-247-3

Anode	1
Cathode	2
Anode	3

### Standards Benefits

- Improve System Efficiency
- Reduction of Heat Sink Requirement
- Essentially No Switching Losses
- Parallel Devices Without Thermal Runaway



### Application

- Consumer SMPS
- Boost Diodes in PFC or DC/DC Stages
- AC/DC Converters



### Order Information

Part Number	Package	Marking
P3D06016K3	TO-247-3	P3D06016K3



## Contents

Features.....	1
Standards Benefits .....	1
Application.....	1
Order Information .....	1
<b>Contents.....</b>	<b>2</b>
1. Maximum Ratings.....	3
2. Thermal Characteristics.....	3
3. Electrical Characteristics .....	4
4. Typical Performance .....	5
5. Package Outlines.....	6

PN Junction Semiconductor

## 1. Maximum Ratings

At  $T_J = 25^\circ\text{C}$ , unless specified otherwise

Parameter	Symbol	Value	Unit	Test condition
Repetitive Peak Reverse Voltage	$V_{RRM}$	650	V	$T_C = 25^\circ\text{C}$
Surge Peak Reverse Voltage	$V_{RSM}$	650	V	$T_C = 25^\circ\text{C}$
DC Blocking Voltage	$V_R$	650	V	$T_C = 25^\circ\text{C}$
Forward Current (Per Leg/Device)	$I_F$	32/64 18/36 8/16	A	$T_C = 25^\circ\text{C}$ $T_C = 125^\circ\text{C}$ $T_C = 160^\circ\text{C}$
Repetitive Peak Forward Surge Current (Per Leg)	$I_{FRM}$	56 31	A	$T_C = 25^\circ\text{C}, t_p = 10\text{ms}$ $T_C = 125^\circ\text{C}, t_p = 10\text{ms}$
Non-Repetitive Forward Surge Current (Per Leg)	$I_{FSM}$	77 66	A	$T_C = 25^\circ\text{C}, t_p = 10\text{ms}$ $T_C = 125^\circ\text{C}, t_p = 10\text{ms}$
Non-Repetitive Forward Surge Current (Per Leg)	$I_{F,MAX}$	475 453	A	$T_C = 25^\circ\text{C}, t_p = 10\mu\text{s}$ $T_C = 125^\circ\text{C}, t_p = 10\mu\text{s}$
Power Dissipation (Per Leg)	$P_{tot}$	167	W	$T_C = 25^\circ\text{C}$
Operating Junction and Storage Temperature	$T_J, T_{STG}$	-55 to +175	$^\circ\text{C}$	
TO-247 Mounting Torque	$M_d$	1 8.8	Nm lbf-in	M3 or 6-32 screw

## 2. Thermal Characteristics

Parameter	Symbol	Values	Unit
Thermal Resistance from Junction to Case (Per Leg)	$R_{\theta JC}$	0.9	$^\circ\text{C}/\text{W}$

### 3. Electrical Characteristics

At  $T_J = 25^\circ\text{C}$ , unless specified otherwise (Per Leg)

Parameter	Symbol	Values			Unit	Test condition
		Min.	Typ.	Max.		
Forward Voltage	$V_F$	/	1.39	1.6	V	$I_F = 8\text{A}, T_J = 25^\circ\text{C}$
			1.65	/		$I_F = 8\text{A}, T_J = 175^\circ\text{C}$
Reverse Current	$I_R$	/	10.2	36	$\mu\text{A}$	$V_R = 650\text{V}, T_J = 25^\circ\text{C}$
			301	/		$V_R = 650\text{V}, T_J = 175^\circ\text{C}$
Total Capacitance	C	/	372	/	pF	$V_R = 0\text{V}, T_J = 25^\circ\text{C}$ $f = 1\text{MHz}$
			36			$V_R = 200\text{V}, T_J = 25^\circ\text{C}$ $f = 1\text{MHz}$
			27			$V_R = 400\text{V}, T_J = 25^\circ\text{C}$ $f = 1\text{MHz}$
Total Capacitive Charge	$Q_C$	/	18.8	/	nC	$V_R = 400\text{V}, I_F = 8\text{A}$ $T_J = 25^\circ\text{C}$
Capacitance Stored Energy	$E_C$	/	2.17	/	$\mu\text{J}$	$V_R = 400\text{V}$

## 4. Typical Performance

At  $T_J = 25^\circ\text{C}$ , unless specified otherwise (Per Leg)

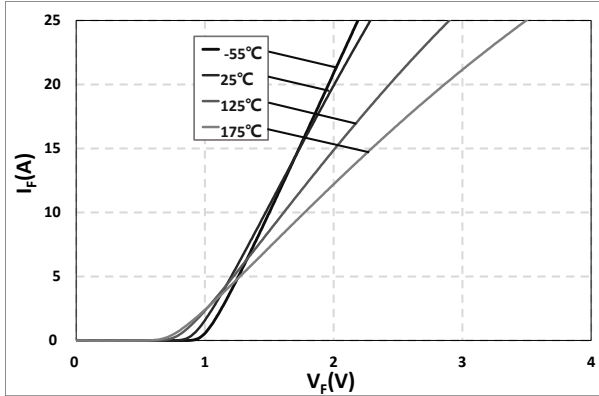

Fig. 1 Typical Forward Characteristics  
 $I_F = f(V_F)$ ;  $T_J = -55^\circ\text{C}, 25^\circ\text{C}, 125^\circ\text{C}, 175^\circ\text{C}$

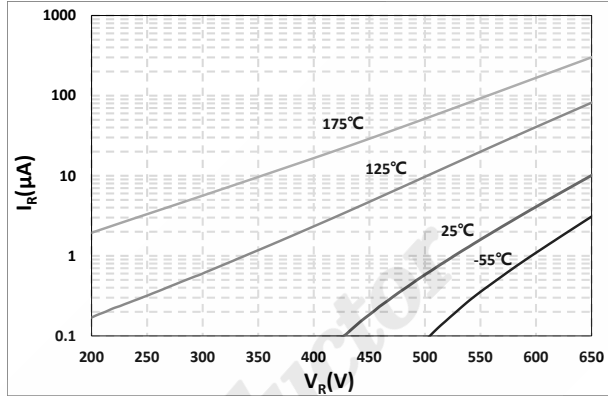

Fig. 2 Reverse Characteristics  
 $I_R = f(V_R)$ ;  $T_J = -55^\circ\text{C}, 25^\circ\text{C}, 125^\circ\text{C}, 175^\circ\text{C}$

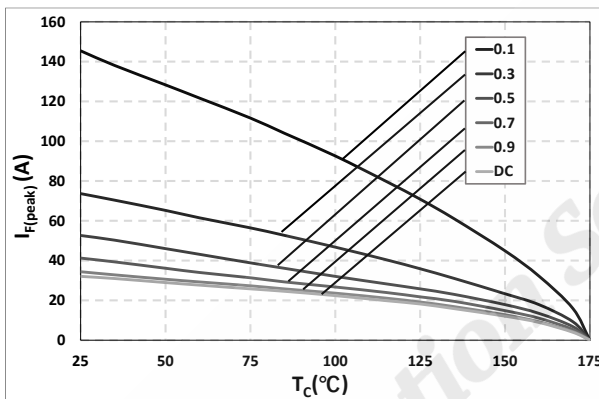

Fig. 3 Current Derating

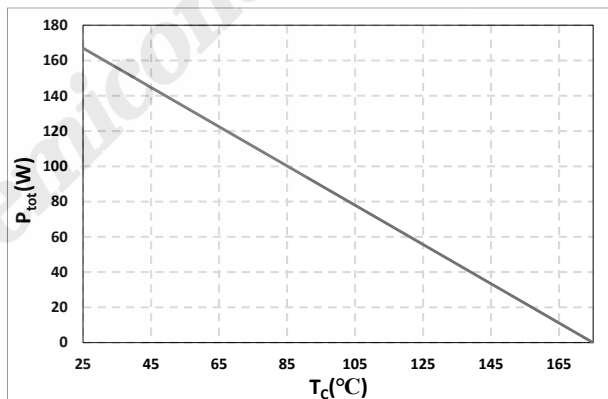

Fig. 4 Typical Power Derating  
 $P_{tot} = f(T_c)$

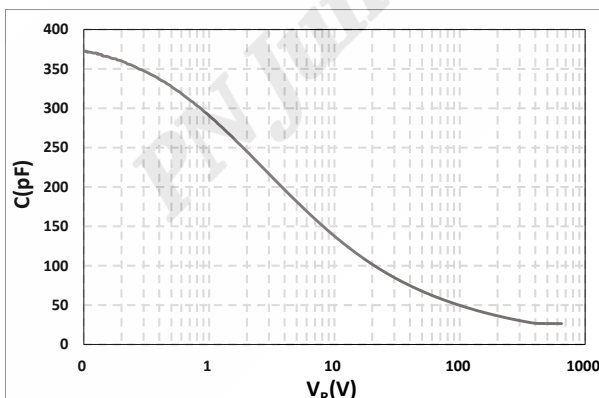

Fig. 5 Typical Total Capacitance  
 $C = f(V_R)$

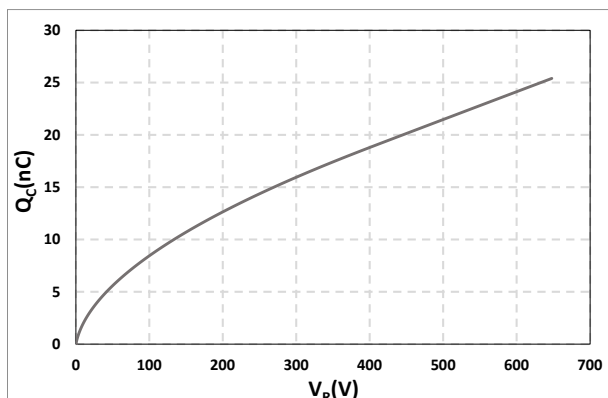

Fig. 6 Typical Total Capacitive Charge  
 $Q_c = f(V_R)$

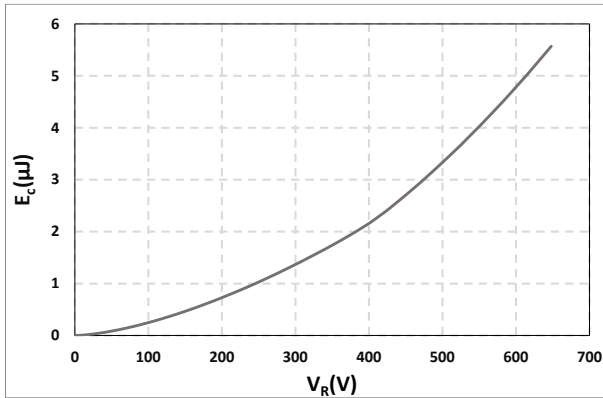

Fig. 7 Capacitance Stored Energy  
 $E_C = f(V_R)$

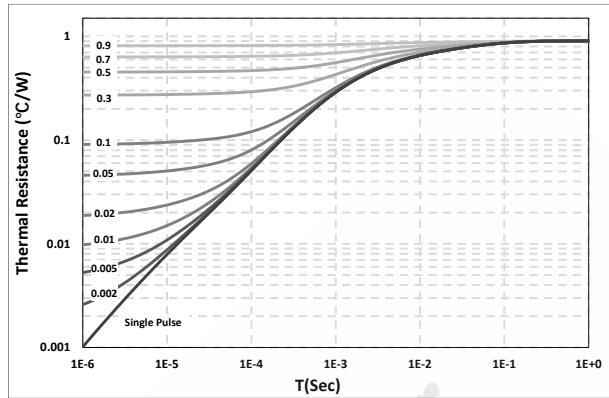
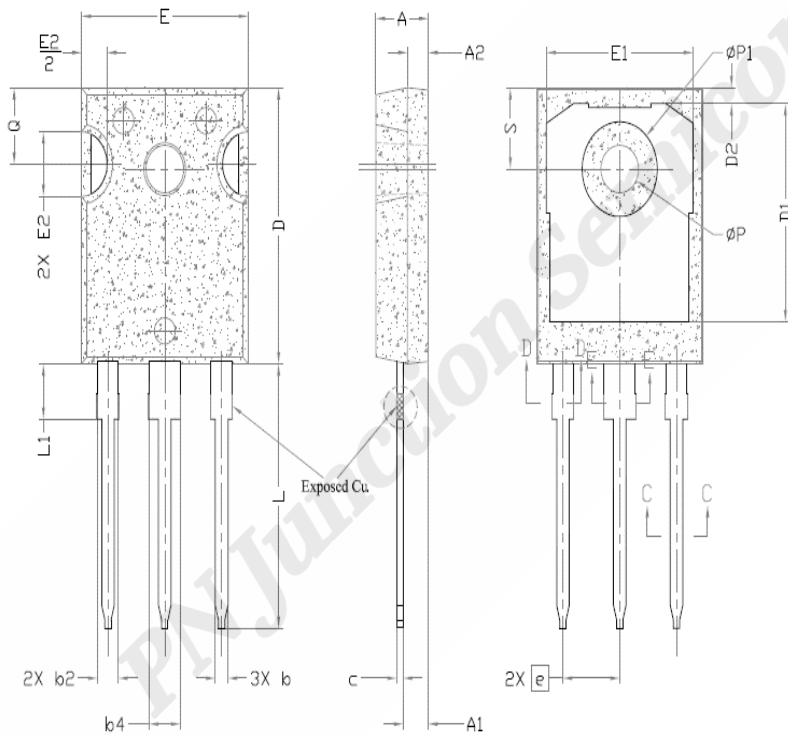

Fig. 8 Transient Thermal Impedance

## 5. Package Outlines



SYMBOL	DIMENSIONS			NOTES
	MIN.	NOM.	MAX.	
A	4,83	5,02	5,21	
A1	2,29	2,41	2,55	
A2	1,50	2,00	2,49	
b	1,12	1,20	1,33	
b1	1,12	1,20	1,28	
b2	1,91	2,00	2,39	6
b3	1,91	2,00	2,34	
b4	2,87	3,00	3,22	6, 8
b5	2,87	3,00	3,18	
c	0,55	0,60	0,69	6
c1	0,55	0,60	0,65	
D	20,80	20,95	21,10	4
D1	16,25	16,55	17,65	5
D2	0,51	1,19	1,35	
E	15,75	15,94	16,13	4
E1	13,46	14,02	14,16	5
E2	4,32	4,91	5,49	3
e	5,44BSC			
L	19,81	20,07	20,32	
L1	4,10	4,19	4,40	6
ØP	3,56	3,61	3,65	7
ØP1	7,19REF.			
Q	5,39	5,79	6,20	
S	6,04	6,17	6,30	

Drawing and dimensions